

Varenummer: 03446040
Beskrivelse: Fluro Heavy Duty Ledleje GE 40 GW-2RS
Hul Ø40
Note: 40

Mål

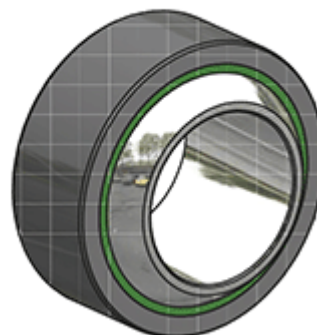
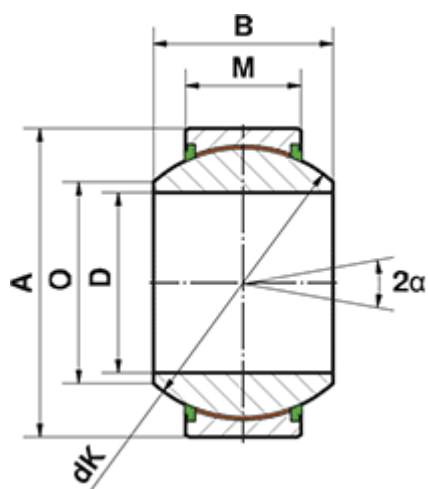

= -	Dynamisk belastning C (kN) = 360
= -	M = 25
= -	O = 44.7
A = 68	Statisk belastning C0 (kN) = 600
a (grader) = 17	Vægt (g) = 530
B = 40	
D = 40	
dK = 60	